

# **Repurposing Mesoscale Traffic Models for Insights into Traveler Heat Exposure Mitigation:**

## **Icarus and the case of Phoenix**

Rui Li, Ben Brownlee, Mikhail Chester, David Hondula, Ariane Middel, Austin Michne, Lance Watkins

Total work count: 5674 words

## Introduction

Climate change will be gradual but the severity and frequency of unprecedented extreme events, such as heat waves, intense storms, drought, and flood will be abrupt (World Health Organization 2008). The consequences of climate change for public health will be dramatic (World Health Organization 2008). Among the climate incited problems, heat persists as a major health hazard. The direct heat impact on public health includes the excess mortality attributed to heat (Kovats and Hajat 2008), multiorgan dysfunction on the human body, near-fatal heat stroke (Dematte et al. 1998), and increased hospitalization of heart disease during heat waves (Schwartz et al. 2004). Beyond these immediate impacts, heat waves and heat stress incited air pollution, wildfire, power and water failures have also caused public health problems or hinder public health action (Kovats and Hajat 2008; Solomon and LaRocque 2019).

As climate change is expected to increase the frequency and intensity of the heat waves (Kovats and Hajat 2008), public health authorities (i.e., CDC) and cities started to build resilience frameworks to help cities and residents to prepare the direct and indirect impact on human health from climate change (Manangan et al. 2019). Heat vulnerability assessment—which identify the spatial distribution and the health outcomes of heat stress—is commonly used in the resilience framework (Conlon et al. 2020; Manangan et al. 2019). Stake holders and health practitioners use the heat vulnerability assessment to understand the people and places that are susceptible to adverse heat impacts and to ‘implement protective interventions’ to increase people’s resilience (Manangan et al. 2019). Non-meteorological factors are important in heat related mortality and mobility (Putnam et al. 2018).

The state-of-the-art in heat vulnerability analysis remains focused on associating negative heat health outcomes with the specific demographic group or the build-environment associated with places of residence. Sun (et al., 2021) proposed a human-centered framework to assess the tree shade provision and the environment with the social economic status to assess the heat-vulnerability for active travel at city scale. Langenheim (et al. 2020) uses an accessibility model to estimate the potential route to schools and use tree-scape model to estimate UV exposure of children walking home from school through these routes. Socioeconomic and demographic factors such as old age, racial and ethnic minority groups, low income and less than high school education, and living alone have been associated with the increasing mortality during heat waves (Hajat et al. 2005; Ostro et al. 2009; Schwartz 2005; Stafoggia et al. 2006). The build environment associated with the urban heat island effect—such as the percentage of impervious surfaces, tree canopy ratio, shading from buildings, and accessible green spaces—are used to identify the heat exposure across communities (Dadvand et al. 2016; Hass et al. 2016; Middel et al. 2014; Yeager et al. 2018). The empirical study shows that the number of heat-related injury has a relationship with the meteorological temperature. The study also shows it’s more related to the age, activity type and location the heat victim was present, and the appearance of cooling infrastructure or equipment in the environment.

While the location and demographic central heat exposure approaches are useful, they ignore the complexity of individual behavior, microclimate, infrastructure, and the effects on individual heat exposure. They all targeted a certain demographic group, or use census track data to indicate the vulnerability. Fewer studies have tracked down the travel pattern or individual trips. Humans can be exposed to heat directly from outdoor activities, or the indoor heat stress because of lacking cooling appliances. People can also be exposed to indirect infrastructure failures attributed to heat waves, such as AC unit dysfunction and water outage.

Outdoor activities are highly related to the heat related mortality in a hot climate, but indoor environments without adequate cooling systems are also relevant to the heat related injuries in warm climates (Iverson et al. 2020). Such as lawn and garden care, recreational outdoor trips are the most common outdoor activities to contribute to heat exposure (Hoehne et al. 2018). Neither the current demographic group approach nor location-based heat exposure analysis can capture these intricate person-based heat exposures. In Maricopa County, most heat-related injuries occur outdoors. Among the indoor heat related

mortality cases, more than 82% was directly related to an inadequately cooled environment (Iverson et al. 2020). Senior population may be more vulnerable to heat because of certain health conditions, but they also tend to be more adaptive by shifting travel time to cooler hours in a day, reducing outdoor trips, or shortening the outdoor travel time. Meanwhile, according to Iverson, from the historical record in Maricopa County, people over 49 years old tend to have more heat-related injuries indoors.

Mesoscale traffic models provide a potential to study the spatial and temporal pattern of residents' and travelers' heat exposure. Activity-based model (ABM) describes the active trips and location for activities together with the demographic feature carrying out these trips and activities. Understanding the active trip route, time, duration, and the environmental temperature these trips were exposed to give us insight into travelers' heat exposure. Together with the parcel AC availability survey result, the trip and activity heat exposure for each transportation agent could be estimated and provide insights for heat exposure for travelers.

To address the dearth of knowledge about person-based and trip-level exposure, we developed the Icarus model. Icarus uses mesoscale traffic model—activity-based model—to analyze the heat exposure of regions of interest at an individual level. The goal with Icarus was to design accurate, granular models of population and temperature behavior for a target region, which could be transformed into a heat exposure model by means of simulation and spatial-temporal joining. By combining and implementing the most robust software and data available, Icarus was able to capture person-based exposure with unparalleled detail. Here we describe the model methodology. We use the metropolitan region of Phoenix, Arizona, USA to carry out a case study using Icarus.

## Method

Icarus is a simulation platform for analyzing people's transportation heat exposure. It simulates the agent heat exposure in the following steps. First, Icarus requires users to prepare an activity-based model (ABM) data, study region parcel map, infrastructure network, and the temperature data prior to the simulation. Secondly, Icarus creates synthetic agents and their trip schedule, prepares the roadway network data, and parses the temperature profile to the roadway network and the parcel map. Then, Icarus simulates each agent's travel routes in the roadway network. In the last step, Icarus uses the geo-spatial location and the time stamp for trips and activities simulated, together with the parsed temperature profile in the previous step, to estimate the heat exposure for trips and agents. Through these steps, Icarus processes the input data and generates the heat exposure for each simulated agent. Figure 1 illustrates the core processes of Icarus and the resources in which it interacts. Currently, Icarus is a python module.

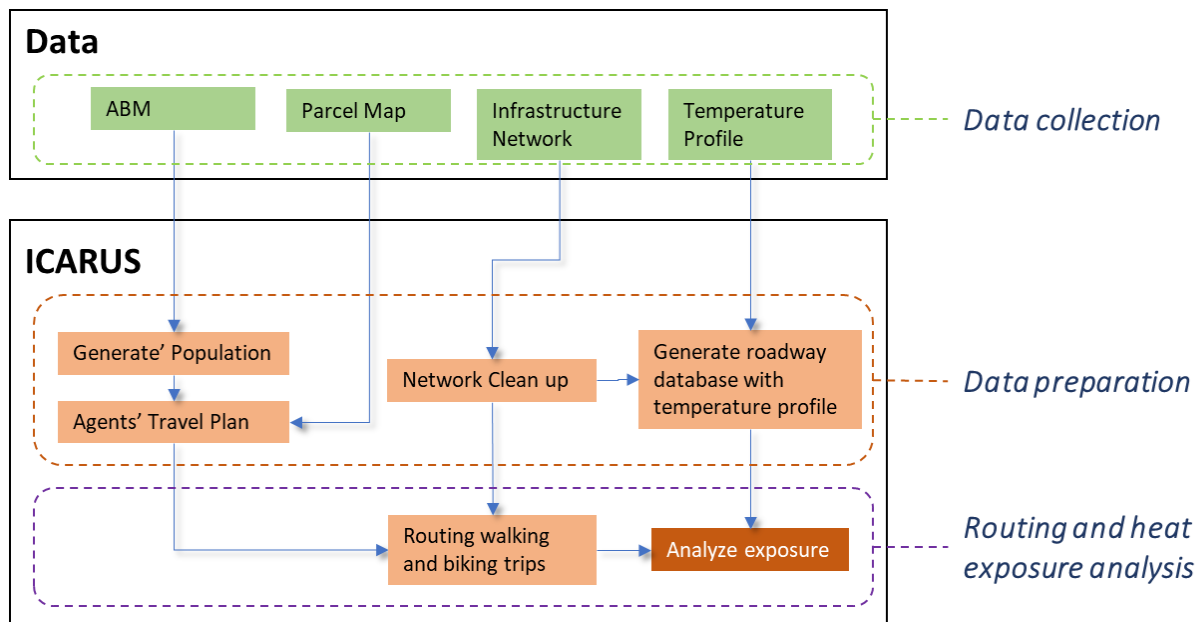

Figure 1: Icarus Framework

### Data collection

Prior to simulation, users need to collect a set of data to be input into Icarus. Data required for Icarus simulation include the ABM data and the parcel data, temperature profile with the time series, and transportation network. To streamline the process, the data required by Icarus can be retrieved or obtained from the public open-source database (i.e., OpenStreetMap, or the NOAA), or requested from the local government and research institutions (i.e., the ABM, the parcel data). Here, we explain the data required in Icarus in detail to guide the users' understanding and extrapolating the data in the future when using Icarus.

### Activity Based Model and Parcel data

The Activity Based Model (ABM) contains the synthetic population. In the generation of the ABM dataset, a population is defined as a set of agents with various demographics that define their needs (i.e., work, groceries, etc.) and resources (i.e., vehicles, time, etc.). In addition, the generation of ABM households and agents make decisions to take certain tours to maximize the achievement of their needs with their given resources. In the ABM, the locations of each household and the activities are given at the Micro Analysis Zones (MAZ) level. The ABM data is usually synthesized from the travel survey and provided by the city or regional planning agencies. Differences of the ABM depends on the ABM providers, but in general, ABM data contains agent, household, and trips' information. Agents'

information includes the demographic of the agent, such as the education, age, gender, job type, etc. Trips' information includes each trip's origin, destination, travel mode, travel time, duration, the purpose of the trip, how long the activity after the trip would last, and the person (i.e. agent) who carried out the trip.

The parcel map was required by Icarus so that locations described in the ABM could be pinned down into parcels in a MAZ. There are tens to hundreds of parcels in one MAZ. The parcel data could be obtained from the local treasury department. Since parcel data is often used for census and taxation purposes, it is accessible and accurate for a given target location. By analyzing region bounds and parcel use codes, activities can be intelligently assigned parcels—and hence exact locations—from their region codes and activity types.

#### Roadway network data

The transportation infrastructure network is used for the synthetic agents to traverse. Icarus introduces the roadway network from OpenStreetMap (OSM 2019). Users need to download the OSM data in the study region into the simulation environment prior to the simulation. Since the OSM website doesn't support large scale network downloads, we recommend using BBBike (Schneider 2021) to download the OSM data. The downloaded network should have both walking and biking networks, as well as the car driving network presented. The roadway network will be cleaned up in Icarus before it is used for the simulation.

#### Temperature data

The outdoor temperature profile used in Icarus can be Daymet (Thornton et al. 2016), measured city temperature, or the estimated mean radiant temperature (MRT), as long as the temperature data covers the analysis region and can be extrapolated into different time sequences. Daymet data uses satellite infra-red temperature measurements to represent the surface temperature for every 100-square meters (Thornton et al. 2016). The observation time is 24-hours, with a 1-hr gap for each time of revisit. The Mean Radiant Temperature (MRT) measures the human body experiencing temperature by considering the environmental radiance. While MRT data has higher resolution (i.e., 15 to 30 meters resolution) and more granular temperature profile (i.e., every 15 minutes), it usually is generated by research institutes and are not universally available. The indoor temperature is derived from the indoor temperature assessment for each parcel. Whether to choose Daymet or MRT data is purely based on the objective from Icarus users.

#### Data preparation

The data obtained from various sources needs to be parsed and joined into an unite dataset. First, Icarus creates synthetic agents' sample from ABM. Each agent has a set of coherent activities and trips that the total duration would add be up to 27 hours of the simulation day (Figure 2). Trips are the movement that an agent transferred from one activity to another activity. Activities locations, such as home, school, lunch, or work, are the origin or destination of the trips connecting two activities. The location of the activities is assigned as the centroid of the parcels which were randomly selected in the activities' MAZ. The indoor temperature was assigned to the activity locations based on the stochastic parcel selection and the indoor temperature assessment for each parcel.

The network needs to be cleaned up and parsed with the temperature profile. Network data obtained from OSM are likely to have topological errors such as overshooting edges, or intersecting edges without node where a turn should be possible. Icarus uses python module GTFS2GMNS (ASU trans AI lab 2020) to clean up these topological errors and filter out the walking and biking infrastructures in the network. The cleaned-up transportation network is then overlayed with the outdoor temperature profile to get the geolocations ID which will be used to source the temperature in the exposure calculation process.

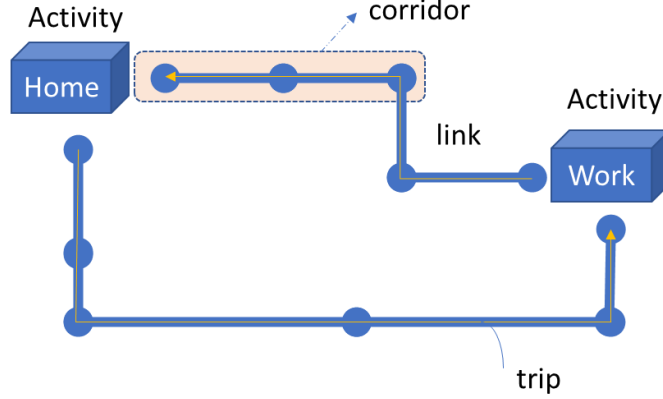

Figure 2: Agent's one day routine layout

Outdoor temperature profile needs to be extrapolated into finer time steps to accommodate the exposure calculation. For example, Daymet provides the average maximum and minimum temperature for a 24-hour period during the month. Icarus extrapolates the Daymet temperature into a 15-minutes time step temperature profile. To do so, Icarus assumes the temperature changes linearly between maximum and minimum temperature. It is also assumed the minimal temperature ( $T_{min}$ ) happens at the time of sunrise (i.e.,  $t_{dawn}$ ) and the temperature reaches maximum temperature ( $T_{max}$ ) at noon (i.e.,  $t_{peak}$ ). For a given time in a day ( $t$ ), the temperature is estimated as equation (1):

$$T(t) = \begin{cases} \left( \frac{T_{max} + T_{min}}{2} - \frac{T_{max} - T_{min}}{2} \right) \times \cos\left( \pi \times \frac{t_{dawn} - t}{24 + t_{dawn} - t_{peak}} \right), & t > t_{dawn} \\ \left( \frac{T_{max} + T_{min}}{2} - \frac{T_{max} - T_{min}}{2} \right) \times \cos\left( \pi \times \frac{t_{peak} - t}{t_{peak} - t_{dawn}} \right), & t_{peak} > t \geq t_{dawn} \\ \left( \frac{T_{max} + T_{min}}{2} - \frac{T_{max} - T_{min}}{2} \right) \times \cos\left( \pi \times \frac{24 + t_{dawn} - t}{24 + t_{dawn} - t_{peak}} \right), & t \geq t_{peak} \end{cases} \quad (1)$$

If the outdoor temperature profile already has a fine time step, such as MRT temperature has a 15 minutes interval, Icarus will skip the temperature extrapolating process.

#### Routing and heat exposure analysis

Icarus uses agent, trip, and the cleaned-up network data to route the trips. In vehicle trips, such as car driving or taking public transit, are not routed but teleported between the origin and destination. Icarus routes the walking and biking trips using the Dijkstra shortest path algorithm. The routed trips would export a set of links ( $\Omega$ ) on their shortest path. Each link also gets a time stamp ( $t$ ) to tag the initial time when an agent was simulated to cross the link.

Exposure analysis takes the result of routing, and the temperature profile generated to calculate the amount of minutes\*degrees exposure each agent experiences in every environment they interact with. An agent one day heat exposure includes the exposure from both trips and activities. The trips' exposure calculates the minutes\*degrees an agent exposed to when traveling from origin activity to the destination. For the teleported in-vehicle trips, the exposure is calculated as the product of the trip's duration given in the ABM and a constant 26.6 degrees air-conditioned temperature. For the routed active trips, the exposure is calculated as incrementing the degree\*minutes an agent is exposed on the trips, which is calculated by multiplying the time agents spend on the trip, and the temperature this agent is exposed to in the environment at the time when the trip or activity happens in equation (2):

$$E_{trip} = \sum_{i \in \Omega} (t_{i+1} - t_i) \times T(t_i) \quad (2)$$

where  $\Omega$  is a set of the sequenced links an active trip routed through.  $t_i$  is the time stamp when an agent was simulated to cross the link  $i$ .  $T(t_i)$  is the outdoor temperature at link  $i$  and time  $t_i$ , which is calculated from equation (1).

To estimate the activities' exposure, land usage codes for parcels were used to predict whether activities would be outdoor, indoor with air condition, or indoor without air condition. When an activity location is indicated to have AC presents, the activity exposure is calculated as the product of activity's duration and a constant room temperature at 26.6 degrees. If there is no AC at the activity's location or if the activity is outdoor, Icarus calculates the exposure as equation (3):

$$E_{activity} = (t_{end} - t_{start}) \times T\left(\frac{t_{end} + t_{start}}{2}\right) \quad (3)$$

where  $t_{start}$  and  $t_{end}$  are the start and end time of an activity.

Each agent total heat exposure during the 27 hours simulation time is calculated as equation (4):

$$E_{agent} = \sum_{j \in \Psi} E_j \quad (4)$$

where  $\Psi$  is the set of coherent activities and trips that an agent planned for the simulation.

## Case study

We implemented Icarus for the City of Phoenix in the Maricopa County, US as a case study. Maricopa County is located in the arid Sonoran Desert. Between 2006 to 2016, Maricopa County had a mean of 140 days with daily maximum temperature above 90 °F (32 °C), and an average of 57 days with daily maximum temperature exceed 105 °F (40.5 °C) (Iverson et al. 2020). Despite the arid and warm weather, Phoenix has been one of the fastest-growing cities in the country since the 1950's (Chow et al. 2012). To monitor the heat stress in Phoenix, researches initiative regarding to the temperature at a finer resolution provide rich temperature profile to be used in Icarus. Meanwhile, the Maricopa Association of Governments (MAG) developed the Phoenix ABM to model synthetic population's travel behavior (Vovsha et al. 2011). The abundance of temperature profile and the available of complete ABM data makes Phoenix a perfect city to carry out Icarus case study. The case study focuses on Phoenix but the whole Maricopa County is included in the analysis since a lot of the commute trips are between Phoenix and the neighboring cities in the County.

The Phoenix case study is carried out using the regional ABM, network, and temperature data with certain assumptions. The synthetic population for Maricopa County is generated from MAG 2018 ABM data. There are 14 different travel modes in ABM shown in Table 1 bin 2. Icarus simplified the 14 travel modes in ABM into car driving, public transit, walking, and biking trips. The 14 travel modes were grouped into four categories based as shown in Table 1. Travel modes for each trip will determine the routing and the exposure analysis method. All walking and biking trips occur outdoor, and the in-vehicle trips are assumed under the room temperature. For the shared trips, we process joint trips together and assign the same start and end parcel to agents who have the sharing trips. We obtained the Maricopa county roadway network from OpenStreetMap (OSM 2019). To present the typical hot weather in Phoenix, we select the temperature profile from the hot summer day. And to compare the sensitivity of heat exposure estimation to temperature profiles, we selected temperature profiles from two different measurement techniques—Daymet and Mean Radiant Temperature. Daymet temperature uses satellite infra-red temperature to represent the surface temperature for every 100-meters surface area (Thornton et al. 2016). The observation time is 24-hours, with daily minimum and maximum temperature. We also chose Mean Radiant Temperature (MRT) in Phoenix to estimate the body temperature heat exposure (Zhang et al.

2019). Derived from Google Street View, MRT considers environmental radiance—such as shading, land surface type—and their effects on the people’s body temperature (Zhang et al. 2019). MRT has a 15 minutes time step and the resolution is between 10 to 30 meters. The MRT data is only available between sunrise to sunset. The temperature before the sunrise and after sunset is assumed to be the same between Daymet and MRT. Although MRT data has higher time and spatial resolution than Daymet, it is limited to the transportation networks where Google Street View is present.

Table 1: transportation modes in Icarus and ABM

<b>Icarus Mode</b>	<b>ABM Modes</b>	<b>Routing</b>
Car driving	SOV, HOV2/driver, HOV3+/driver, HOV/passenger, taxi	Teleported
Public transit	Conventional transit walk access, Conventional transit KNR, Conventional transit PNR, Premium transit walk access, Premium transit KNR, Premium transit PNR, School bus	Teleported
Walking	walk	Shortest distance
Biking	bike	Shortest distance

We further analysis the travelers’ heat exposure and vulnerability using the result exported from Icarus. People’s heat stress is related to the environmental temperature they are exposed to, the time they spend in that environment, if they are doing physical activities, and if they are used to the heat environment. For instance, Iverson et al. (2020) found Non-Arizona residents are 5 times more likely to experience heat-related death outdoors than Arizona residents. We adapted the wet bulb globe temperature work/rest chart (Mesonet 2016) to select a set of temperature-duration thresholds for active trips that were carried out by acclimated travelers (Table 2). The walking and biking are classified as moderate and heavy work according to their metabolic equivalent of task (MET) level assessed Tudor-locke et al.(National Cancer Institute 2020; Tudor-Locke et al. 2009). These thresholds were used to distinguish the high heat exposure trips, and to identify the vulnerable demographic groups that carried out these trips.

Table 2. Vulnerable trip's thresholds

<b>heat exposure risk level</b>	<b>WBGT (F°)</b>	<b>WBGT (C°)</b>	<b>trip duration (minutes)</b>	
			<b>walking (moderate work)</b>	<b>biking (heavy work)</b>
no risk	78-79.9	25.5-25.9	continuous	50
low	80-84.9	26-28.9	50	40
moderate	85-87.9	29-30.9	40	30
high	88-90	31-31.9	30	20
extreme	>90	>32	20	10

## Results

Icarus generates the trip planned for each agent during the 27 hours simulation time, including the routes agent chose for each trip, and the activities they did at the end of the trip. Icarus also generated the heat exposure for each agent on the trip. These data can be linked to the demographic database comes with the original ABM data, to group, and analysis the demographic features of the heat vulnerable groups.



Together with the GIS information for trips, activities, and the corridor environmental properties, we could target the locations where high heat exposure happens. The results of Icarus are presented as the simulation, the exposure estimation, and the vulnerable trips.

### Simulation results

From the MAG ABM data, the majority of the population only use vehicle in their daily travel plan. In total, 3.8 million agents were extracted from the ABM data, and 18.6 million trips were simulated. 11 agents were dropped because we couldn't generate their 27 hours travel plan. Among the 3.8 million agents, 13.1% agents have at least one biking or walking trip in their daily travel plan, while the rest agents (86.9%) only have in vehicles trips. Less than 0.7% of the total sample population have only walking or biking trips in their plan. 12.4% of the agents have both in vehicle and active travel mode. The average walking trips' distance is 1.54 kilometers, and the average biking trips' distance is 2.72 kilometers. Since there is lack of survey data to validate the actual path each agent took, we briefly compare the travel speed of the walking and biking trips generated from Icarus with the average active speed.

All age groups in the population use active trips only in their daily travel plan, higher ratio of young and senior population uses active only trips in their daily travel plan. The synthesized population have three kinds of travel plan in the 27 hours simulation time: 1) the agents only travel in car or buses; 2) agents travel in vehicles but also have biking or walking trips in their daily plan; 3) agents only travel by walking and biking. Although the majority (86.9%) of the population chose to stay in vehicle to finish their daily trips, the rest (13.1%) who chose to have at least one active trip in their travel plan shows strong correlation with the populations' age. High percentage of people above 65 years old and people under 20 years old in the ABM are using walking and biking as their only travel mode (Figure 3). The population between age 35 to 45 have the ratio of active only trips in their daily plan. The daily trip mode arrangement signaled the potential heat vulnerable demographic group. The younger and senior population are more vulnerable to heat exposure because of their health conditions or lack of access to vehicles (find a citation). But since they are more vulnerable, they also adopt to resilience strategies to avoid outdoor trips during the hottest hours.

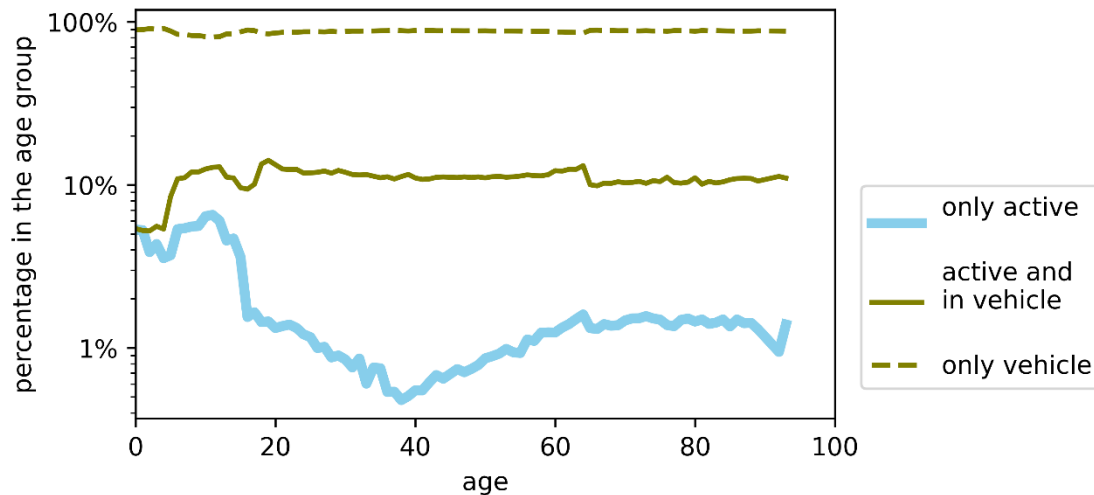

Figure 3: age groups for different travel patterns

One way to see populations adaptation to heat exposure is to check the active trips start time between different age groups (Figure 4). Although population under 20 have higher ratio of active only trips, the time they carry out these trips are either in the early morning or late in the afternoon. They avoid the trips at the hottest time of the day (i.e., 12 PM to 2 PM). Population ages between 19 and 53 simulated to carry

out half of the total trips in the system. Under 12% of the population between age 20 to 60 chose to at least one active trip in their daily travel plan (Figure 3). Population aging between 20 to 60 have their peak time for active trips is between 12 PM to 2 PM—the hottest time during the summer day in Phoenix. Checking the ABM data, the purpose of trips during the peak time was related to lunch break. People ages above 61 year have majority of their active trips happening between 8 am to 14 pm. They could be vulnerable to the summer heat during the middle of the day as well.

Table 3. Simulation Statistic

	Number of trips	% of total trips	Trip duration (min) mean (5% ,95%)	Trip distance (km) mean (5% ,95%)	Travel speed (KPH) mean (5% ,95%)
walking	1,030,014	5.55%	5.75 (1.30, 14.04)	1.54 (0.22, 3.58)	7.1 (1.42, 17.3)
biking	147,142	0.79%	8.7 (2.1, 21.3)	2.72 (0.5, 7.23)	19.7 (9.1, 48.0)
Car driving	17,245,967	92.89%	9.13 (1.2, 34.15)	N/A	N/A
Public Transit	142,869	0.77%	74.8 (20.48, 142.05)	N/A	N/A

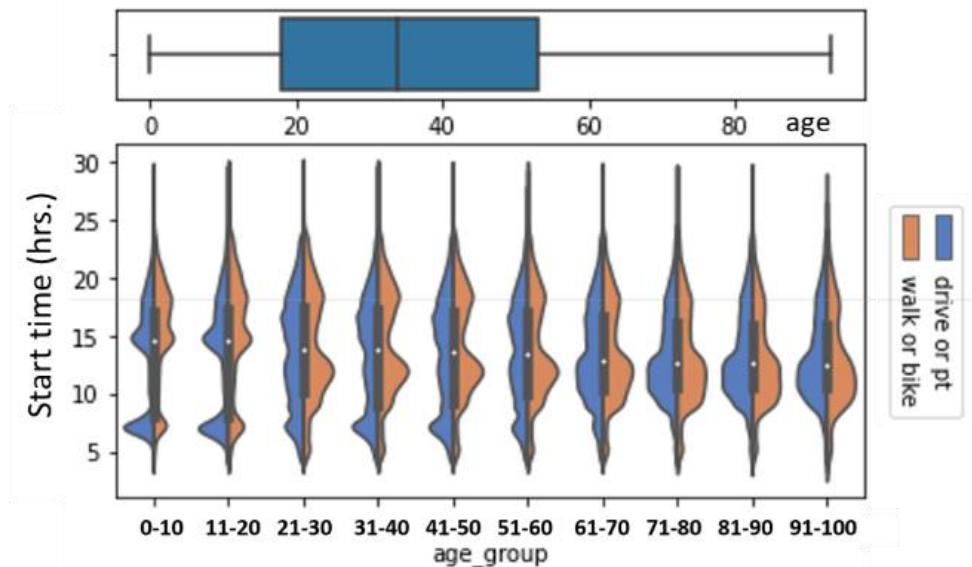

Figure 4: trip duration and validation with ABM

#### Exposure Estimation results

The exposure analysis estimated heat exposure under both Daymet and MRT profile for the population that finished travel simulation. The temperature profile choice does not affect the heat exposure of in-vehicle trips. Because we assumed all vehicles provide a constant 26.6 °C temperature for passengers and drivers. Contrary to in-vehicle trips, heat exposure of walking and biking trips is very sensitive to the choice of temperature profiles. All simulated walking and biking trips have DayMET heat exposure. But since MRT data does not cover the full studied area, only a portion of the active trips have their MRT heat exposure results.

Agents exposure is the aggregation of the exposure from trips and activities in each agent 27 hours travel plan. In the current simulation, all activities exposure is assumed to be under 26.6 °C environmental temperature. The heat exposure calculated from MRT profile has a wider range than the exposure calculated from DayMET profile. The population which finished the simulation in Icarus would all have their Daymet heat exposure estimation. But only 72% of the agent who have at least one walking and biking trips in their daily travel plan would have their MRT heat exposure estimation results. The population who have their trips all in-vehicles would have their total heat exposure equals to 720 °C\*hours, since the activities and the trips temperature are set to be 26.6 °C thought the 27 hours. Agents with active walking and biking trips are expected to have different than 720 °C\*hours heat exposure, especially for those 0.67% agents who travel only by walking and biking (Figure 5).

Populations—who have only walking and biking trips in their daily plan—have their daily heat exposure ranges from 719 degrees\*hours to 817 degrees\*hours. The lower exposures value is resulted from the outdoor active trips in the early morning or late afternoon, where the air temperature is lower than the indoor and in vehicle temperature. The selection of temperature profile would affect the heat exposure results. MRT exposure results demonstrate a wider range of heat exposure, but some locations don't have MRT available. While MRT temperature profile has more details, it doesn't cover the whole study area. On the other hand, Daymet data has full coverage, but missing the resolution to show detailed temperature difference in small scale. On average, heat exposure calculated with MRT temperature profile is higher than the heat exposure calculated with Daymet temperature profile (Figure 5). Compared to the ABM agents, 29% of the active trips only agents and 27% of the mixed in vehicle and active trips agents were missing from MRT exposure results. This is because the MRT profile doesn't cover the whole study region. It's difficult to stipulate a threshold for high exposure agents.

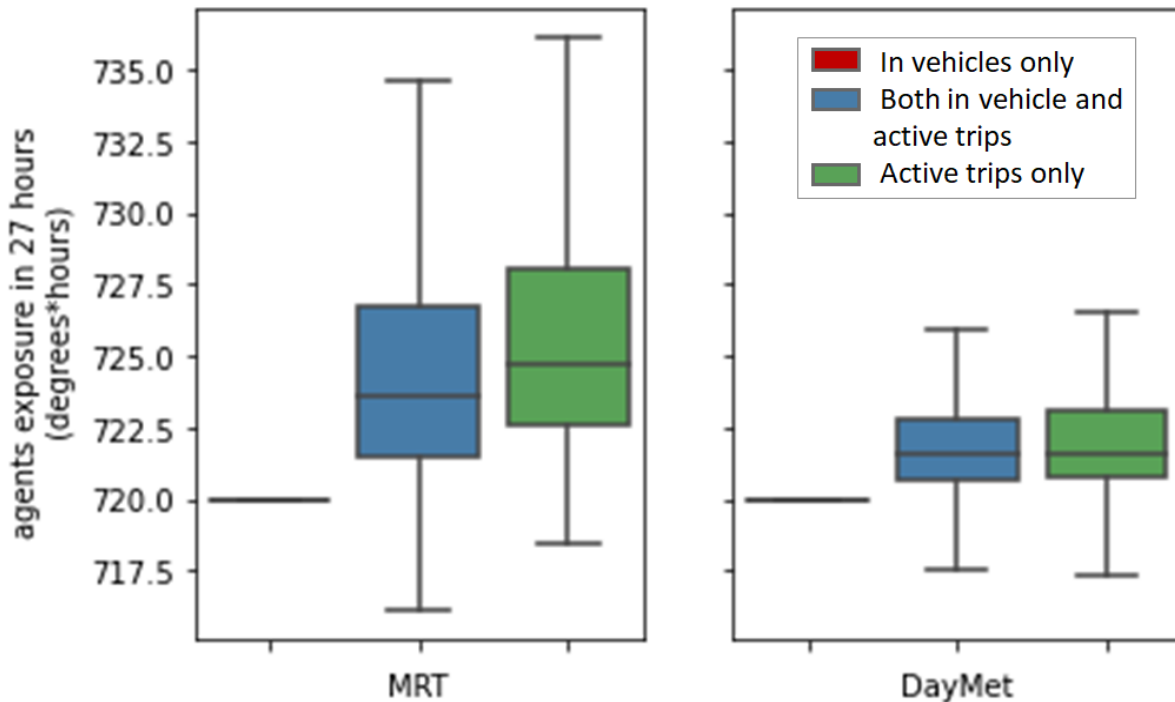

Figure 5: Agent heat exposure in 27 hours

### *Vulnerable trips*

We use the selected work intensity and duration threshold to filter out all the vulnerable walking and biking trips. As plotted below, the number of walking and biking trips carried out by different age is plotted as below. In ABM data, people under age five and over age 65 have the relatively lower number of active trips comparing to other age group. But for agents age below five, on average, 29% of their active trips are classified as heat vulnerable trip based on the threshold we selected. Meanwhile, for population over 65 years old, less than 1% of their walking and biking trips are above the heat vulnerability threshold we selected (Figure 6). Reasons for these contrasts could be that for toddlers under age 5 don't carry out walking and biking trips by themselves rather than escort by teenagers or adults. These escorted trips could be carried out during the hot hour in the high heat environment or have longer duration. While for seniors, their walking and biking trips tend to be short duration, even though they carried out active trip during the hottest hour of the day, their trips are not captured by the threshold we selected. For the population aging between six to 64, around 20% of their walking and biking trips are above the defined heat vulnerable threshold.

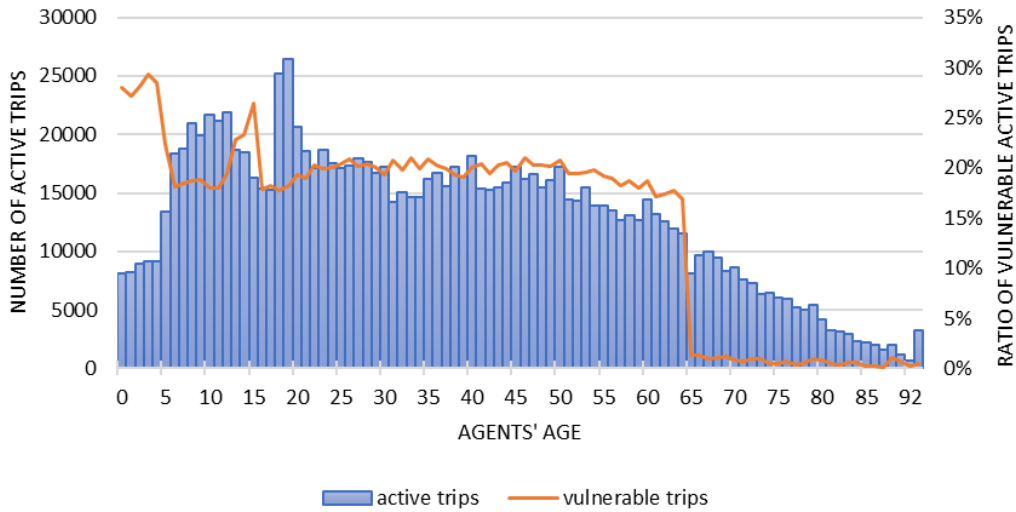

Figure 6. Total Active Trips' Histogram and Ratio of Heat Vulnerable Trips between Age Group

We filtered out the links in the City of Phoenix municipal region and calculated the link flow for all active trips as well as the most vulnerable trips on each arc (Figure 7). Links used by most active trips are not all used by vulnerable trips. In the city of Phoenix region, the busiest link in the network is simulated to up to over 3000 trips per day. Arc in the network that traveled most by active trips are around shopping malls, business centers, city parks, and medical centers (e.g., Carl T Hayden Veterans Affairs Medical Center, Banner Estrella Medical Center). Links used over 2000 times in the simulation day clusters near the west side of highway north 101 and I 17 intersections at the Deer Valley, downtown Phoenix, where shopping mall with retail and dining are concentrated. Link flow counted by vulnerable trips at maximum is 1500 trips per link per day. The arcs where the number of vulnerable trips is high, are not always at the high link flow location. These links have high vulnerable link flow is either because, these links have high environmental temperature that cause the trips with high temperature exposure, or trips using these links take place during the hottest hours of the day, or the trips using these links have longer duration.

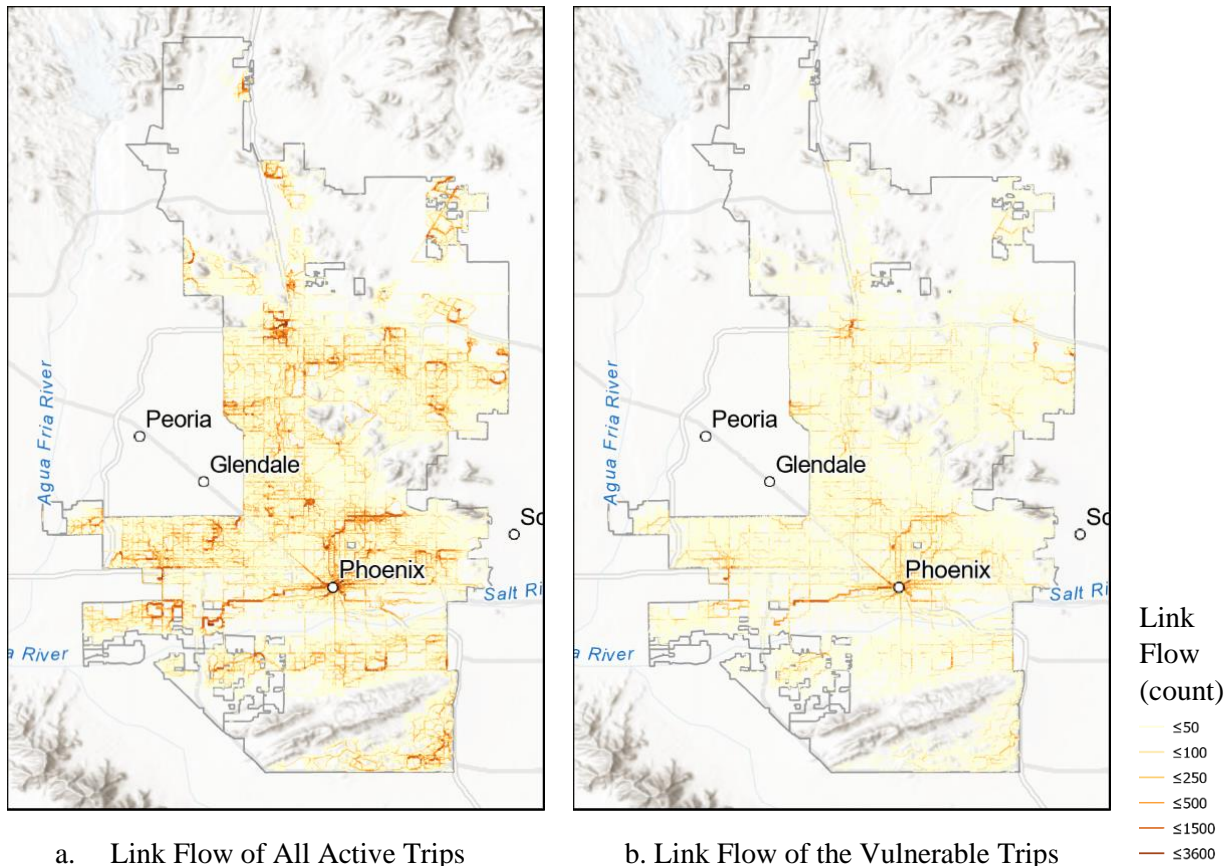

Figure 7. Link Flow Map of All Active Trips vs. Heat Vulnerable Trips

### Discussion :

As global warming is adding uncertainty to the reliability to our infrastructures and cities, a low or even zero emission scenario is believed to be the key for us to slow down the pace of global warming. Climate and environmental change may alter people's behavior patterns. When it is too hot to do outdoor activities--to garden, or for a walk--people shift their travel schedule to avoid excessive heat exposure (Zivin and Neidell 2010), or forgo physical activity entirely (Obradovich and Fowler 2017). Considering the climate change induced temperature rise, physical activities may decline during the summer in southern states (Obradovich and Fowler 2017). The appearance of heat mitigation infrastructures—such as shaded corridors, community buses, or cooling centers—could also influence individual's travel behavior. This could potentially decrease individuals heat exposure, since the outdoor activities are either shifted to cooler hours or forgo. The rising heat could also significantly increase individual vulnerability if one could neither shift travel plans nor find cooling shelters on the trip. Comparing to in vehicle trips, walking and biking trips don't consume fossil fuel or electricity and emit nearly none GHG emission. Active trips are also good for citizen's health. The COVID-19 pandemic also accelerates residents' increasing demand for street network to do walking and biking other than just workout in the gym. But the traditional car centered transportation planning and roadway design leaves little consideration for the mesoscale walking and biking environment. Icarus provides a detailed analysis of active trips location and heat exposure for different demographic groups based on the ABM, temperature, and network data. The outputs of Icarus include the link flow for walking and biking trips in the network, heat exposure for each trip simulated in the network, accumulated agent exposure, and so on. The findings from Icarus can assist transportation planners to identify the heat vulnerable trips and potential locations for heat exposure mitigation planning. Based on people's adaptivity in different climate regions, users of Icarus can also

adjust the duration and temperature thresholds to filter out the vulnerable population and trips from Icarus output.

### Limitation

The limitations of the Icarus come from the internal simplification to stream flow the simulation, and external data quality added on uncertainty. Internally, Icarus doesn't consider the heat exposure for public transit trips in the current version. Icarus also doesn't have the capacity to analysis the schedule shifts caused by the environmental change from the infrastructure improvement, such as increasing the biking lane or tree shading in a corridor may induce some car driving agents shift to walking and biking. Also, shortest path is not always depicting how people choosing their walking and biking route.

Externally, ABM, temperature profile, and the transportation network data quality would affect Icarus simulation result. For instance, the ABM used in the case study tends to be calibrated for one day with "peak travel" which likely occurs in February or March, outside of the warm season. Our estimation has the potential to overestimate the number of vulnerable trips, since some of the trips may cancelled (i.e., schools have summer break) or shift time (i.e., construction sites shift operation hours) during the warm season. The temperature profile would also affect the analysis result accuracy, as showed from the agent heat exposure result. The transportation network may over simplified or not having the walking and biking infrastructures presented.

Despite these limitations, Icarus still provides a module for insights into travelers' heat exposure, and provide quantitative method for planners to address and reduce the travelers heat exposure.



## Reference

- ASU trans AI lab. (2020). "GTFS2GMNS."
- Chow, W. T. L., Brennan, D., and Brazel, A. J. (2012). "Urban heat island research in phoenix, Arizona." *Bulletin of the American Meteorological Society*, American Meteorological Society, 93(4), 517–530.
- Conlon, K. C., Mallen, E., Gronlund, C. J., Berrocal, V. J., Larsen, L., and O’neill, M. S. (2020). "Mapping Human Vulnerability to Extreme Heat: A Critical Assessment of Heat Vulnerability Indices Created Using Principal Components Analysis." *Environmental Health Perspectives*, 128(9).
- Dadvand, P., Bartoll, X., Basagaña, X., Dalmau-Bueno, A., Martinez, D., Ambros, A., Cirach, M., Triguero-Mas, M., Gascon, M., Borrell, C., and Nieuwenhuijsen, M. J. (2016). "Green spaces and General Health: Roles of mental health status, social support, and physical activity." *Environment International*, Elsevier Ltd, 91, 161–167.
- Dematte, J. E., O’Mara, K., Buescher, J., Whitney, C. G., Forsythe, S., McNamee, T., Adiga, R. B., and Ndukwu, I. M. (1998). "Near-fatal heat stroke during the 1995 heat wave in Chicago." *Annals of Internal Medicine*, American College of Physicians, 129(3), 173–181.
- Hajat, S., Armstrong, B. G., Gouveia, N., and Wilkinson, P. (2005). "Mortality Displacement of Heat-Related Deaths." *Epidemiology*, 16(5), 613–620.
- Hass, A., Ellis, K., Reyes Mason, L., Hathaway, J., and Howe, D. (2016). "Heat and Humidity in the City: Neighborhood Heat Index Variability in a Mid-Sized City in the Southeastern United States." *International Journal of Environmental Research and Public Health*, MDPI AG, 13(1), 117.
- Hoehne, C. G., Hondula, D. M., Chester, M. V., Eisenman, D. P., Middel, A., Fraser, A. M., Watkins, L., and Gerster, K. (2018). "Heat exposure during outdoor activities in the US varies significantly by city, demography, and activity." *Health and Place*, Elsevier Ltd, 54(July), 1–10.
- Iverson, S. A., Gettel, A., Bezold, C. P., Goodin, K., McKinney, B., Sunenshine, R., and Berisha, V. (2020). "Heat-Associated Mortality in a Hot Climate: Maricopa County, Arizona, 2006-2016." *Public Health Reports*, 135(5), 631–639.
- Kovats, R. S., and Hajat, S. (2008). "Heat Stress and Public Health: A Critical Review." *Review in Advance on Annu. Rev. Public Health*, 29, 41–55.
- Langenheim, N., White, M., Tapper, N., Livesley, S. J., and Ramirez-Lovering, D. (2020). "Right tree, right place, right time: A visual-functional design approach to select and place trees for optimal shade benefit to commuting pedestrians." *Sustainable Cities and Society*, Elsevier Ltd, 52, 101816.
- Manangan, A. P., Uejio, C. K., Saha, S., Schramm, P. J., Marinucci, G. D., Langford Brown, C., Hess, J. J., and Luber, G. (2019). *Assessing Health Vulnerability to Climate Change A Guide for Health Departments Climate and Health Technical Report Series Climate and Health Program, Centers for Disease Control and Prevention.*
- Mesonet. (2016). *Wet Bulb Globe Temperature Category Work/Rest and Water Intake.*
- Middel, A., Häb, K., Brazel, A. J., Martin, C. A., and Guhathakurta, S. (2014). "Impact of urban form and design on mid-afternoon microclimate in Phoenix Local Climate Zones." *Landscape and Urban Planning*, 122, 16–28.
- National Cancer Institute. (2020). "Metabolic Equivalent of Task Values for Activities in American Time Use Survey and 2002 Census Occupational Classification System."  
<<https://epi.grants.cancer.gov/physical/met/atus-met.php?major%5B%5D=01&major%5B%5D=02&major%5B%5D=03&major%5B%5D=04&major%5B%5D=06&major%5B%5D=07&major%5B%5D=08&major%5B%5D=09&major%5B%5D=10&major%5B%5D=11&major%5B%5D=12&major%5B%5D=13&major%5B%5D=14&major>



- %5B%5D=15&major%5B%5D=16&keywords=&metval\_min=&metval\_max=> (Mar. 4, 2021).
- Obradovich, N., and Fowler, J. H. (2017). “Climate change may alter human physical activity patterns.” *Nature Human Behaviour*, Nature Publishing Group, 1(5), 1–7.
- OSM. (2019). “Planet dump.” *OpenStreetMap contributors*, <<https://planet.openstreetmap.org/>> (Mar. 23, 2020).
- Ostro, B. D., Roth, L. A., Green, R. S., and Basu, R. (2009). “Estimating the mortality effect of the July 2006 California heat wave.” *Environmental Research*, Academic Press, 109(5), 614–619.
- Putnam, H., Hondula, D. M., Urban, A., Berisha, V., Iñiguez, P., and Roach, M. (2018). “It’s not the heat, it’s the vulnerability: attribution of the 2016 spike in heat-associated deaths in Maricopa County, Arizona.” *Environmental Research Letters*.
- Schneider, W. (2021). “BBBike extracts OpenStreetMap.” <<https://extract.bbbike.org/>> (Apr. 5, 2021).
- Schwartz, J. (2005). “Who is Sensitive to Extremes of Temperature?” *Epidemiology*, 16(1), 67–72.
- Schwartz, J., Samet, J. M., and Patz, J. A. (2004). “Hospital Admissions for Heart Disease: The Effects of Temperature and Humidity.” 15(6), 755–761.
- Solomon, C. G., and LaRocque, R. C. (2019). “Climate Change — A Health Emergency.” *New England Journal of Medicine*, New England Journal of Medicine (NEJM/MMS), 380(3), 209–211.
- Stafoggia, M., Forastiere, F., Agostini, D., Biggeri, A., Bisanti, L., Cadum, E., Caranci, N., de??Donato, F., De Lisio, S., De Maria, M., Michelozzi, P., Miglio, R., Pandolfi, P., Picciotto, S., Rognoni, M., Russo, A., Scarnato, C., and Perucci, C. A. (2006). “Vulnerability to Heat-Related Mortality.” *Epidemiology*, 17(3), 315–323.
- Sun, Q., Macleod, T., Both, A., Hurley, J., Butt, A., and Amati, M. (2021). “A human-centred assessment framework to prioritise heat mitigation efforts for active travel at city scale.” *Science of the Total Environment*, 763, 143033.
- Thornton, P. E., Thornton, M. M., and Vose, R. S. (2016). *Daymet: Annual Tile Summary Cross-Validation Statistics for North America, Version 3*.
- Tudor-Locke, C., Washington, T. L., and Ainsworth, B. E. (2009). “Linking the American Time Use Survey (ATUS) and the Compendium of Physical Activity Methods and Rationale.” *Journal of Physical Activity and Health*, 347–353.
- Vovsha, P., Freedman, J., Livshits, V., and Sun, W. (2011). “Design Features of Activity-Based Models in Practice Coordinated Travel–Regional Activity Modeling Platform.” *Transportation Research Record: Journal of the Transportation Research*, W. Sun, 300, 19–27.
- World Health Organization. (2008). *ACM Agenda 7.2 - Climate Change and Health*.
- Yeager, R., Riggs, D. W., DeJarnett, N., Tollerud, D. J., Wilson, J., Conklin, D. J., O’Toole, T. E., McCracken, J., Lorkiewicz, P., Xie, Z., Zafar, N., Krishnasamy, S. S., Srivastava, S., Finch, J., Keith, R. J., DeFilippis, A., Rai, S. N., Liu, G., and Bhatnagar, A. (2018). “Association between residential greenness and cardiovascular disease risk.” *Journal of the American Heart Association*, American Heart Association Inc., 7(24).
- Zhang, Y., Middel, A., and Turner, B. L. (2019). “Evaluating the effect of 3D urban form on neighborhood land surface temperature using Google Street View and geographically weighted regression.” *Landscape Ecology*, Springer Netherlands.
- Zivin, J. G., and Neidell, M. J. (2010). *Temperature and the Allocation of Time: Implications for Climate Change*.

